

ANGLE ALU SX390 2 DÉPARTS 60°

ASX4021

12 kg - 60°

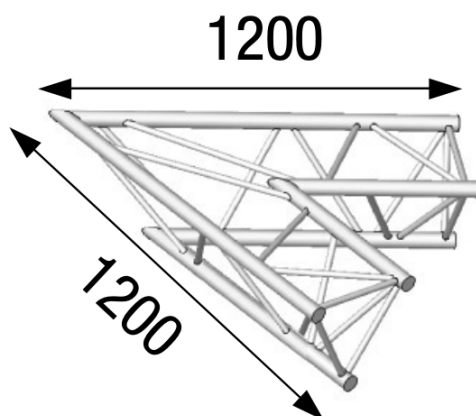

AL ASX4021

Principales caractéristiques

ANGLE ALU SX390 2 DÉPARTS 60°. (Ref : AL ASX 4021)

