

ANGLE ALU 290 CARRÉ 2 DÉPARTS 60°.

ASZ 21

7,1 kg - 60°

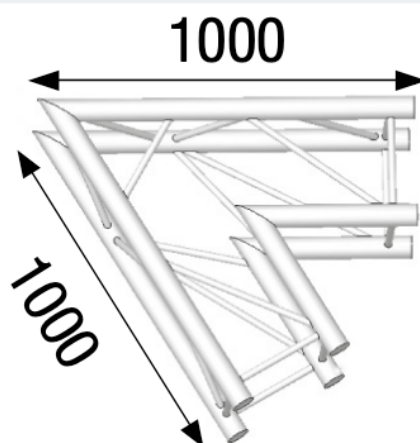

AL ASZ21M

Principales caractéristiques

ANGLE ALU 290 CARRÉ 2 DÉPARTS 60°. (Ref : AL ASZ 21 M)

