

ANGLE ALU 250 TRIANGULAIRE 2 DÉPARTS 135°

ASD25

3 kg - 135°

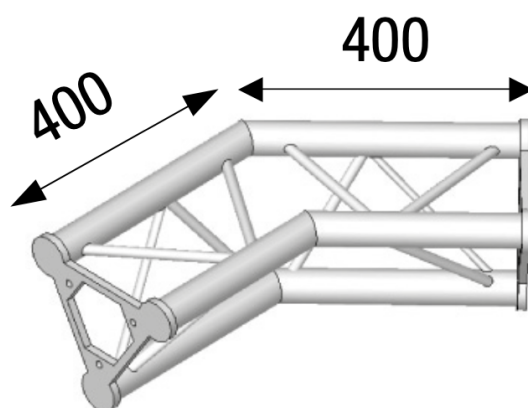

AL ASD25

Principales caractéristiques

ANGLE ALU 250 TRIANGULAIRE 2 DÉPARTS 135°. (Ref : AL ASD 25)

