

ANGLE 4D 90° SECTION 250 ALU CARRÉ

ASC2541

5,8 kg - 90°

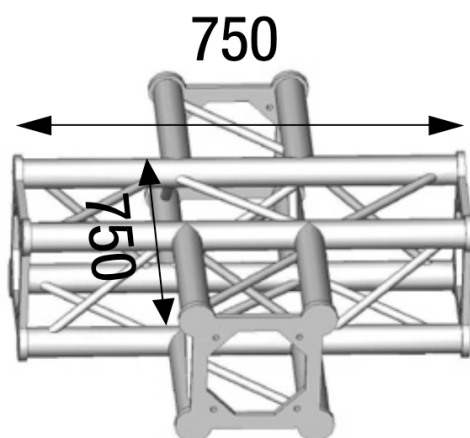

AL ASC2541

Principales caractéristiques

ANGLE 4D 90° SECTION 250 ALU CARRÉ. (Ref : AL ASC 2541)

