

ANGLE 4D 90° SECTION 250 ALU CARRÉ

ASC2542

6,5 kg - 90°

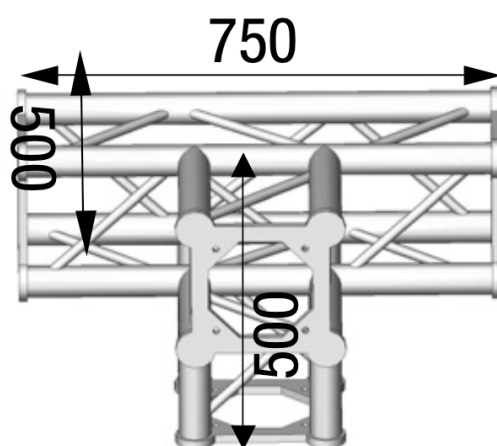

AL ASC2542

Principales caractéristiques

ANGLE 4D 90° SECTION 250 ALU CARRÉ. (Ref : AL ASC 2542)

