

ANGLE 2D 90° SECTION 150 ALU CARRÉ

ASC1522

0,8 kg - 90°

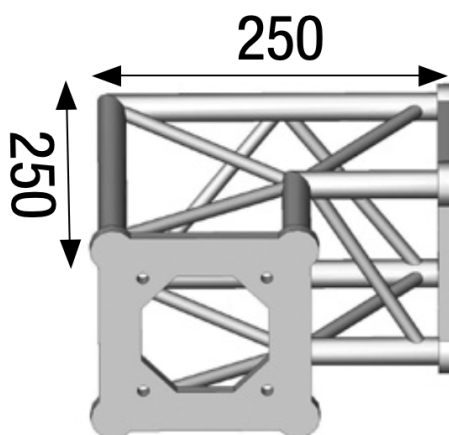

AL ASC1522

Principales caractéristiques

ANGLE 2D 90° SECTION 150 ALU CARRÉ. (Ref : AL ASC 1522)

