

ANGLE 2D 45° SECTION 250 ALU CARRÉ

ASC1520

1,1 kg - 45°

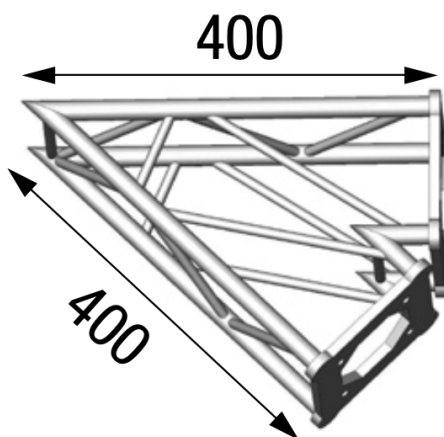

AL ASC1520

Principales caractéristiques

ANGLE 2D 45° SECTION 250 ALU CARRÉ. (Ref : AL ASC 1520)

